

TWENTY EIGHT INDUSTRIAL



INDUSTRIAL &
COMMERCIAL
RADIANT HEATING
& COOLING PANELS







INTRODUCTION

SPC is a UK based specialist manufacturer and supplier of heating & cooling equipment to both public and private sectors. With 30 years' experience we are a highly established supplier in the radiant heating and cooling market offering a comprehensive range of products for both standard and specialist integrated ceilings along with many free hanging sail/raft solutions.

Our recent additional options for directly heating and cooling MDF/plasterboard, along with the iTwenty Eight industrial product mean SPC now offer radiant solutions across all building sectors.

Before introducing the iTwenty Eight to our range SPC stringently considered the market's requirements and our intention was to meet with the criteria listed below.

INDUSTRIAL CRITERIA:

- Large bore waterways with low resistances
- Possibility of long modules and panel lengths (up to 70m)
- Able to be used with LTHW, MTHW & steam heating media
- Energy efficient with high radiant performance
- Lightweight but robust construction
- Pre-assembled and offering ease of installation
- Available in plain and perforated radiant surface finishes
- Adjustable fixing positions.
- Ease of maintenance
- Dual usage (heating & cooling)
- Additional lighting and colour options.

iTWENTY EIGHT

ADDITIONAL ENERGY SAVINGS OF UP TO 15%

The unique construction of this product incorporates partial room side waterways and integrated anti-convective edge profiles. These features reduce local convection at high level, resulting in lower air temperature above the

panel and an increased radiant effect (81%) This is particularly important in high bay areas and can result in up to 15% energy and operating cost savings.

KEY ■ Radiant Heat ■ Convective Heat

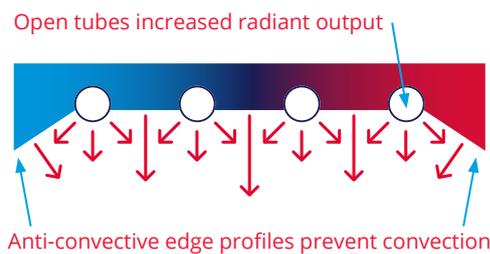

iTwenty Eight

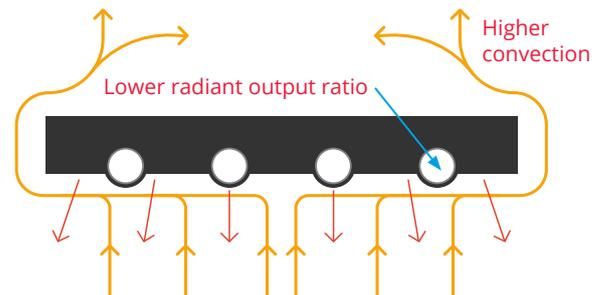

Alternative industrial panel

PRODUCT DESCRIPTION

The iTwenty Eight panels have large bore waterways (28mm x 1.5mm thick) and incorporate header arrangements for flow splitting/joining. Individual modules of up to six metres offer opportunities for long runs of panels combined with low pressure drops and can be arranged to maintain same end flow and return pipes at runs of up to 70m. This reduces the extent of services, pipework and installation time and costs.

The product's radiant surface is formed from a series of prefitted/removable lightweight aluminium profiles either plain or perforated. The finished profile exposes the underside of the water tubes which combines with the anti-convective edges to increase the radiant output to 81% of the total with a radiant emissivity of 0.95.

The combination of steel waterways and the aluminium radiant fascia allows the weight of the panel to be reduced without compromising its strength and durability. The panels have been tested for ball resistance to DIN 18032. If required the radiant profiles can be replaced on site without special tooling.

BENEFITS OF THIS PRODUCT

- High quality durable product with reduced operating weight
- Large bore waterways with low flow resistance
- Proven reduction in energy consumption
- Completely pre-assembled
- Multi module runs up to 70m joined on site with standard press fittings
- Same end connections for reduced installation costs
- Adjustable hanging bars for simple site installation
- Fascia plate sections replaceable in situ; no special tools required
- Can be used for heating & cooling
- Fire resistant insulation
- Range of additional options available

TEST LABORATORY SMOKE ANALYSIS

The smoke test Figure 1 below shows the iTwenty Eight edge profiles reducing the convection above the panel.

iTwenty Eight reduced convection



Figure 1 (iTwenty Eight)

Figure 2 shows an alternative panel without the profiles clearly increasing convection above.

Alternative industrial panel increased convection



Figure 2 (Alternative Panel)

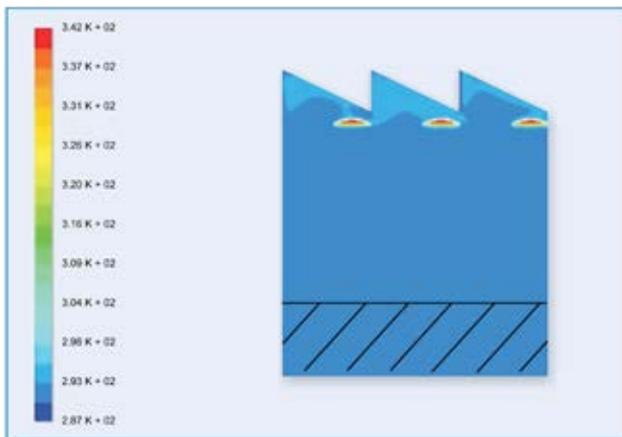

Reduced convection with higher radiant fraction results in lower high level air temperatures.

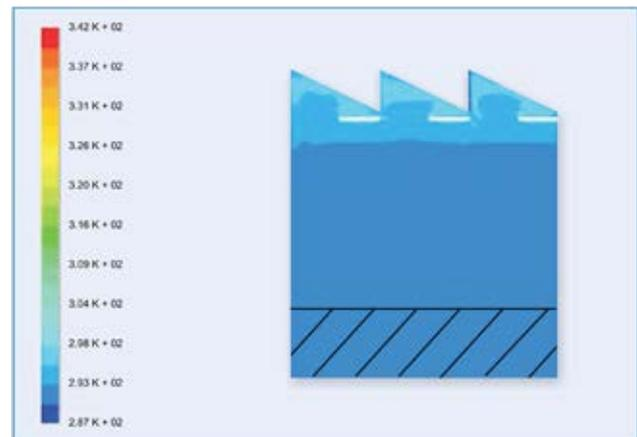

Increased convection results in higher high level air temperatures.

The lower high level air temperature reduces roof heat losses and the higher radiant fraction is available to heat the occupied workspace. This is of particular benefit in tall bay areas and results in energy savings of up to 15%.



CONSTRUCTION

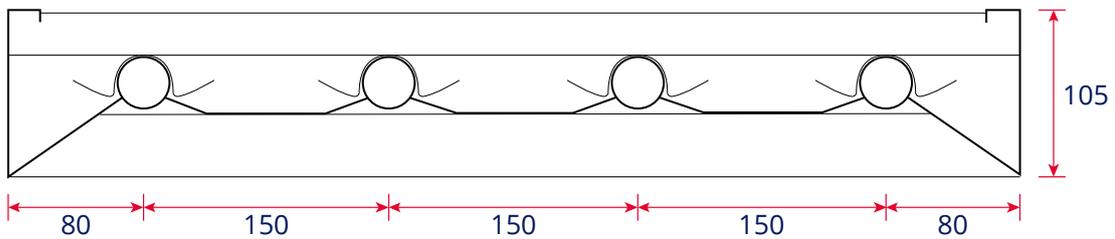
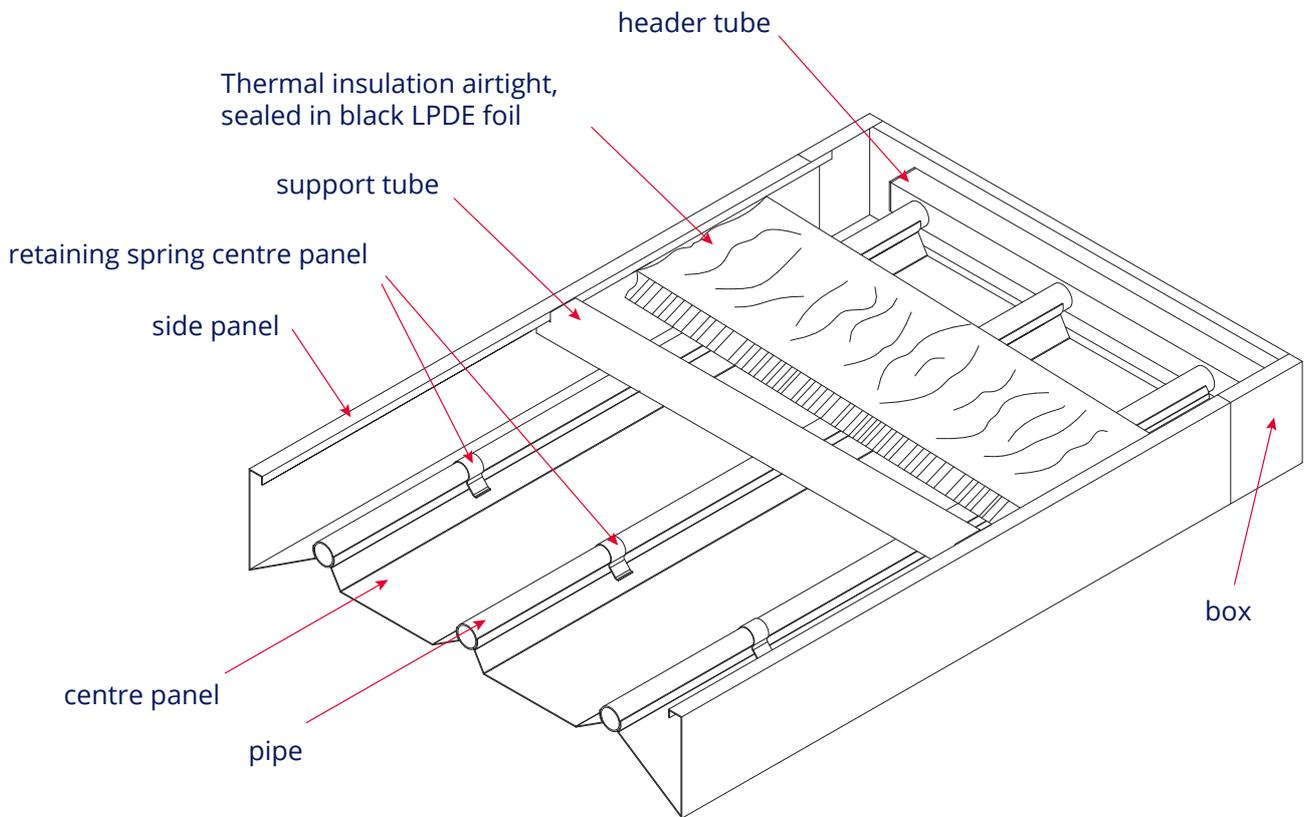

Optional Lighting

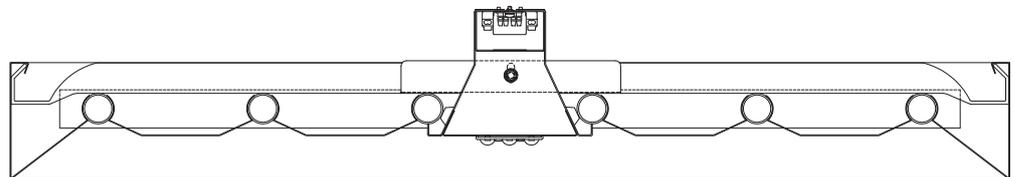

Width (mm)	310	460	610	760	910	1060	1210	1360	1510
Weight inc. water (kg/m)	4.6	6.6	8.7	10.7	12.7	14.8	16.8	18.8	20.8
No. of tubes	2	3	4	5	6	7	8	9	10

ITWENTY EIGHT TECHNICAL SPECIFICATION

- Radiant panels by SPC model iTwenty Eight Industrial
- Product to have 28mm OD x 1.5mm thick steel waterways
- Aluminium front panel, replaceable without special tooling
- Profiled surface with partially exposed underside waterways for increased radiant fraction
- To have 81% radiant output and an emissivity of 0.95
- Integral anti convective side profiles for reduced convective losses
- Fitted with integrated movable hanging bars
- 40mm thick mineral wool, fully foil encapsulated LDPE, (black) Fire resistance in accordance with EN13501.B1
- Outputs to EN14037
- Same end connections on all lengths
- Twin header arrangement if needed (up to 60m runs)
- Modules joined by press fittings supplied with panels
- Module connection covers and end boxes

Optional Extras

- Ball guards to DIN 18032 part 3
- Paint to RAL9010 as standard
 - Special Paint (full panel) RAL:
 - or
 - Special Paint (Tubes) RAL:
 - Special Paint (Panel surface) RAL:
- Perforated radiant surface
- Integrated lighting

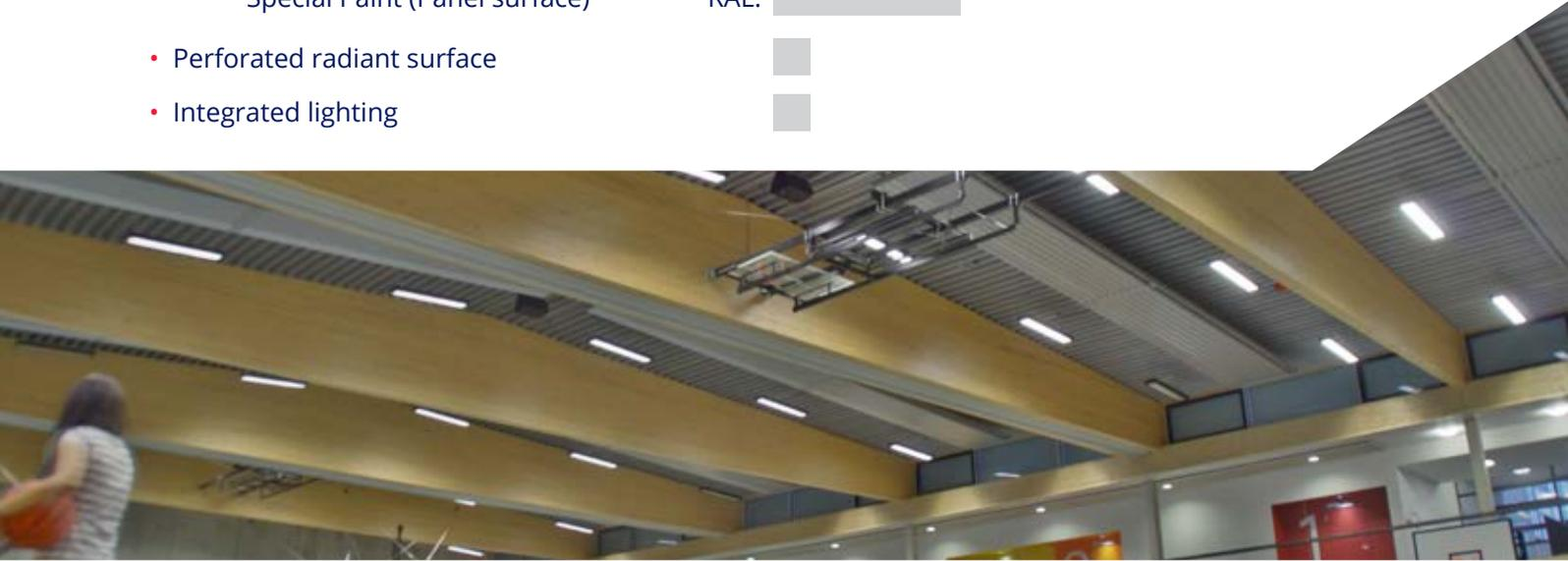



OUTPUTS

HEATING OUTPUTS

Width (mm)	310	460	610	760	910	1060	1210	1360	1510
Excess temperature (K)	Heat output W/m acc. to DIN EN 14037 T2:2003								
70	225	305	385	466	547	628	709	790	872
68	218	295	373	451	529	607	685	764	843
66	211	285	360	435	511	586	662	738	814
64	204	276	348	420	493	566	639	712	785
62	197	266	335	405	475	546	616	686	757
60	190	256	323	390	458	525	593	660	728
58	182	247	311	376	440	505	570	635	700
56	175	237	299	361	423	485	547	610	672
54	168	227	286	346	406	465	525	584	644
52	161	218	274	331	388	445	502	559	616
50	154	208	262	317	371	426	480	534	588
48	148	199	250	302	354	406	458	509	561
46	141	190	239	288	337	387	436	485	534
44	134	180	227	274	321	367	414	460	507
42	127	171	215	260	304	348	392	436	480
40	120	162	203	245	287	329	371	412	453
38	113	153	192	231	271	310	349	388	427
36	107	144	180	218	255	291	328	365	401
34	100	135	169	204	238	273	307	341	375
32	94	126	158	190	222	254	286	318	349
30	87	117	147	177	206	236	266	295	324
28	81	108	135	163	191	218	245	272	299
26	74	99	125	150	175	200	225	250	274
24	68	91	114	137	160	182	205	227	250
22	61	82	103	124	145	165	185	206	226
20	55	74	92	111	130	148	166	184	202

COOLING OUTPUTS

Width (mm)	310	460	610	760	910	1060	1210	1360	1510
Excess temperature (K)									
8	30	44	58	72	87	101	115	130	144
10	38	56	74	93	111	129	147	166	184
12	46	68	91	113	135	158	180	202	225

SPC SERVICES / DESIGN SUPPORT

With over 30 years experience in radiant systems, SPC's technical sales team can offer design advice, panel selection and site visits to help reduce the stress of designing an industrial radiant panel system.

We are happy to guide you through the process from initial design right the way through to installation and after care service.

Contact us on 0116 249 0044 or email spc@spc-hvac.co.uk for advice and to talk to one of our engineers who will be happy to help.

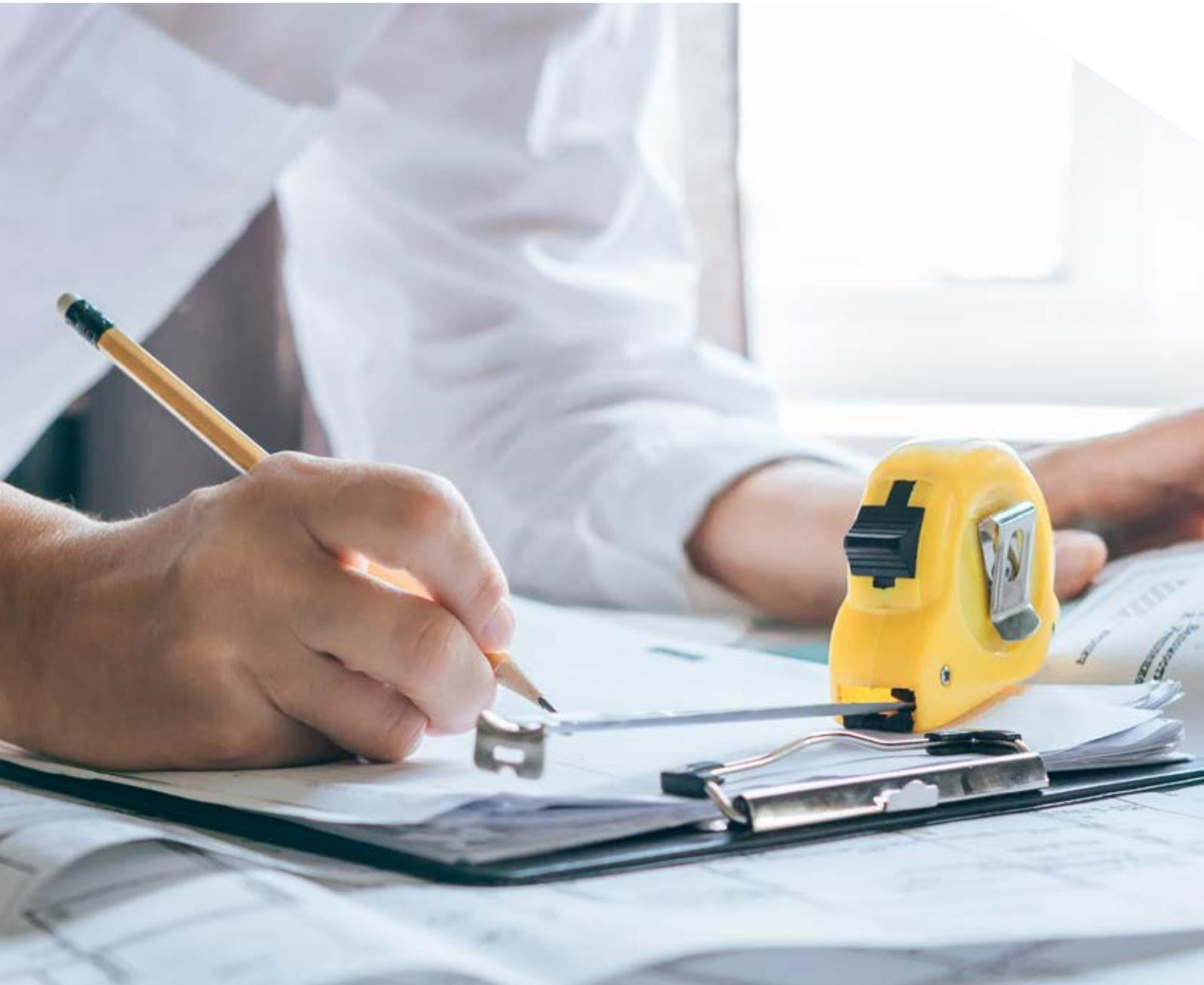

CASE STUDY EXAMPLES

The iTwenty Eight product has been installed in a number of locations around Europe and is widely considered to be one of the market leading industrial panels.

For a copy of one of the below case studies, please feel free to contact us on spc@spc-hvac.co.uk or call 0116 249 0044.



TRAIN DEPOT



PLAYMOBIL FACTORY



LUFTHANSA FACTORY



MILITARY HANGER



SPC House, Evington Valley Road, Leicester LE5 5LU
T: 0116 249 0044 | E: spc@spc-hvac.co.uk | W: spc-hvac.co.uk

iTwenty Eight Radiant Heating & Cooling

Issue 1